

WALL PANELS

STANDARD PANELS
 PANEL SIZE WILL VARY TO MEET
 SPECIFICATION CRITERIA

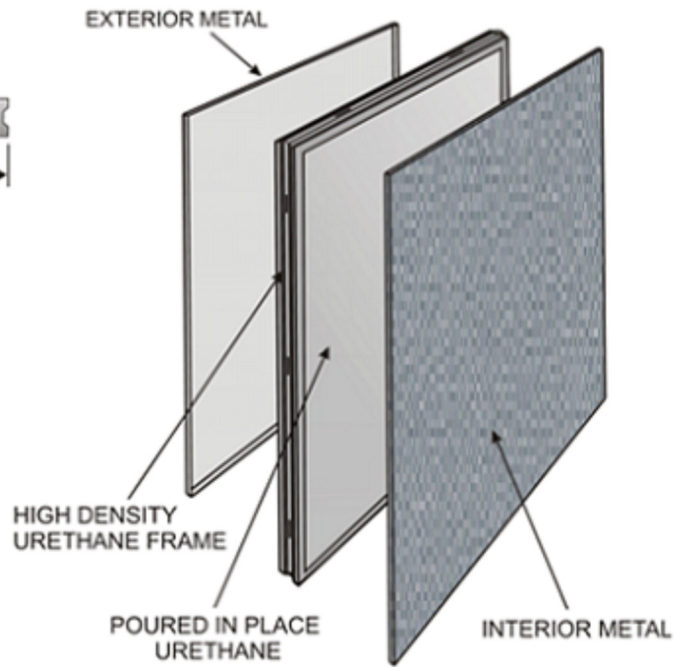

PANEL JOINT

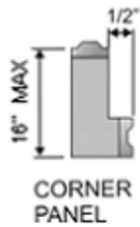
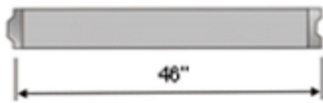
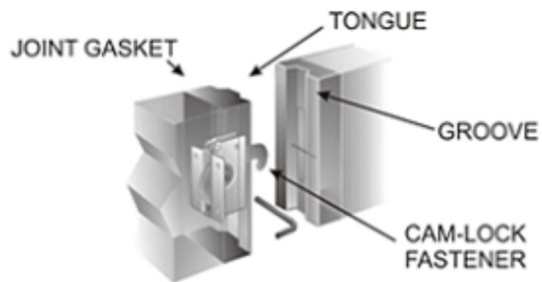

MAXIMUM AVAILABLE SINGLE PANEL HEIGHT – 26'-0

Span charts and Load calculations are availibale upon request

TOP PANELS

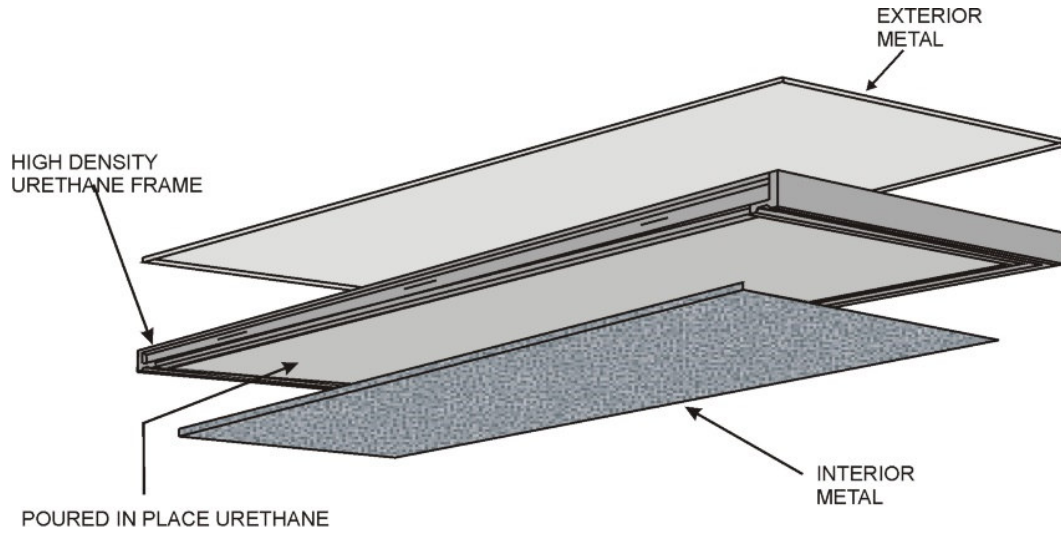

STANDARD PANELS

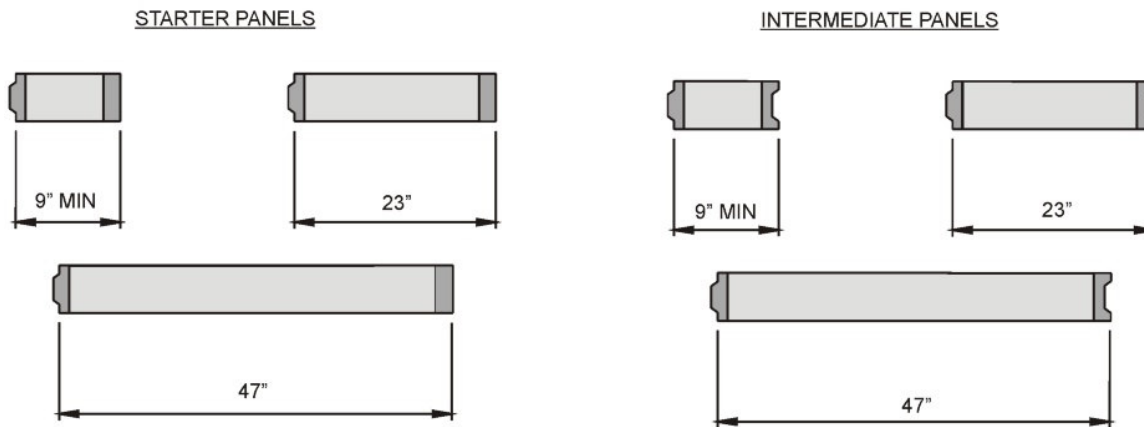

Span charts and Load calculations are available upon request

Due to continuous improvement programs, specifications are subject to change without notice.



STANDARD PANELS

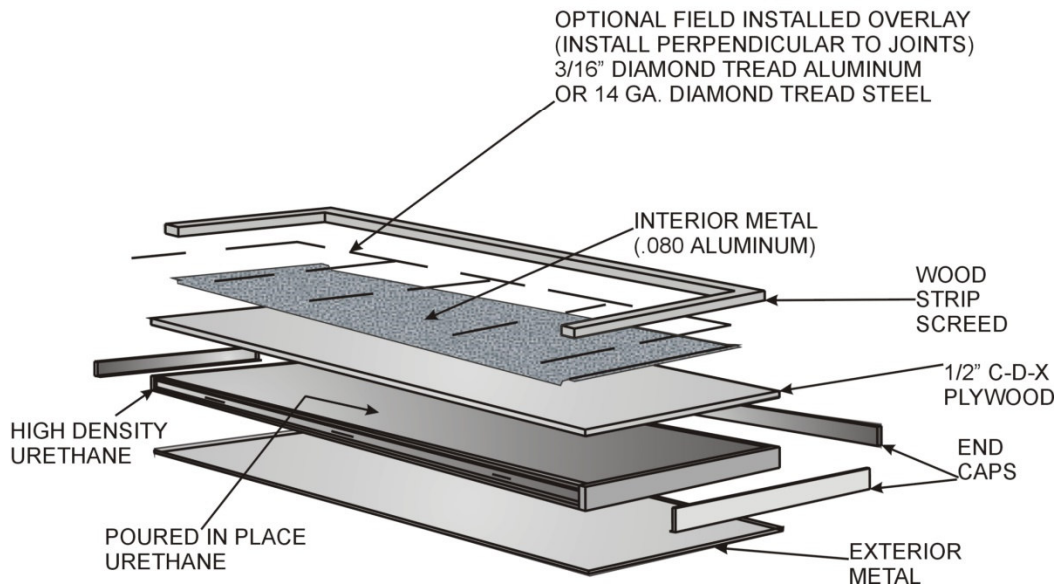
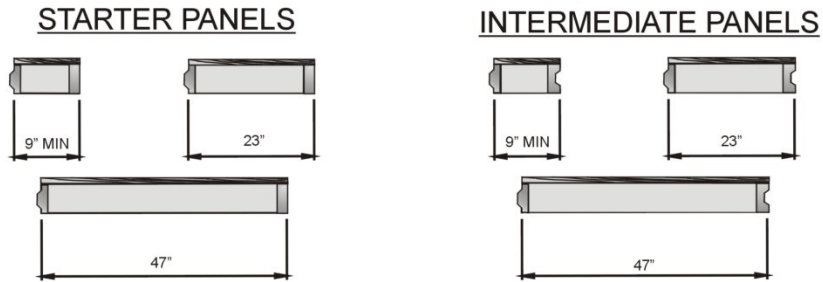

MAXIMUM AVAILABLE SINGLE PANEL LENGTH- 12'-0"

Floor Load Ratings:

Application	Construction	Uniform Load*
Foot Traffic	Galvanized or Stainless Steel Skins over Foam	700 psf
Hand Truck	1/2" Plywood Under Any Metal	1000 psf
Pallet Jack	1/2" Plywood Under Any Metal with Field Applied 3/16" DTA	2500 psf
Super Floor	3/4" Plywood Under Any Metal with stiffeners at 12" O.C. and Field Applied 3/16" DTA	5000 psf

Due to continuous improvement programs, specifications are subject to change without notice.